

BAÑERAS

BATHS

BAIGNOIRES



Soleil Quadra

Bañera acrílica de 180x80cm, con pestaña excéntrica y doble respaldo. Está compuesta por un faldón perimetral, lo que posibilita su instalación freestanding.

Acrylic 180x80cm bathtub with asymmetrical rim and twin backrest. Includes an integrated moulded bath panel, permitting free-standing installation.

Baignoire acrylique de 180x80 cm à bord asymétrique et double dossier. Équipée de tablier périmétral, ce qui permet de l'installer en freestanding.



SOLEIL QUADRA

CARACTERÍSTICAS • FEATURES • CARACTERISTIQUES

CLUB

PLANOS • DRAWINGS • PLANS

center (SX)

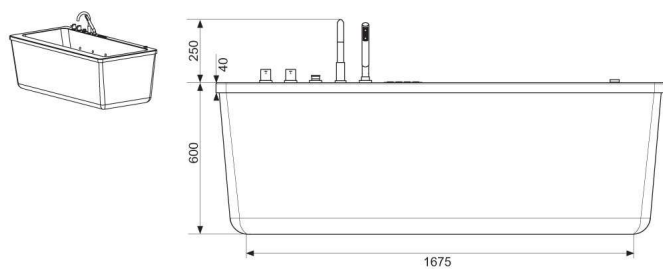

encastre • built-in • encastrement

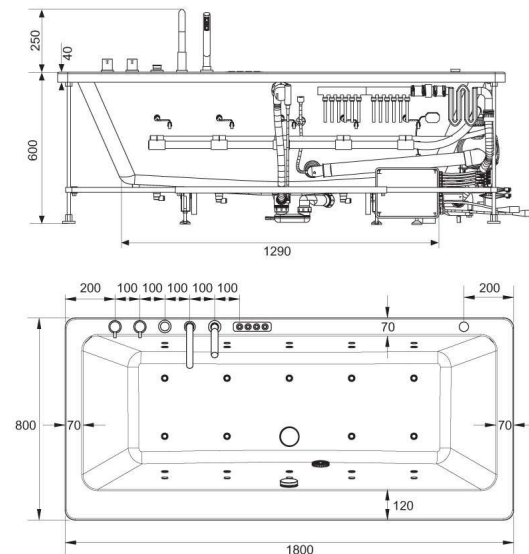

PREINSTALACIÓN • PRE-INSTALLING • PRE-INSTALLATION

center (SX)

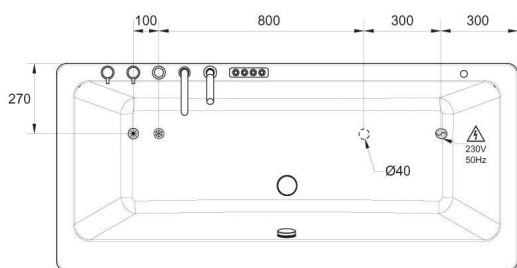

encastre • built-in • encastrement

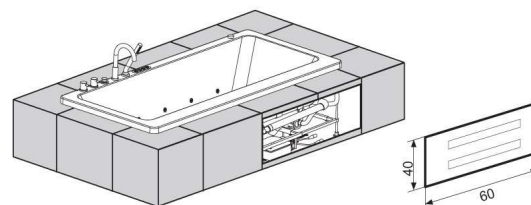
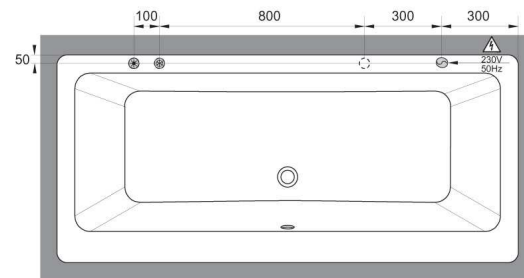

- Para la versión encastre se debe dejar un registro de 600x400 mm, en la zona indicada, con el fin de tener acceso para un mejor mantenimiento.
- A 600 x 400 mm inspection space shall be left in the indicated zone, for the recessed version, in order to ensure access for better maintenance.
- Pour la version à encastrement, il est nécessaire de prévoir un regard de visite de 600x400 mm dans la zone indiquée, de manière à permettre l'accès en vue de réparations futures.

	Toma de agua caliente Hot water connections Prise d'eau chaude		Desagüe Drain Écoulement
	Toma de agua fría Cold water connections Prise d'eau froide		Toma eléctrica Electrical connections Câblage électrique

BAIGNOIRES

BATHS

BAÑERAS

SOLEIL QUADRA

CARACTERÍSTICAS • FEATURES • CARACTÉRISTIQUES

DATOS DE EXPEDICIÓN • EXPEDITION DATA • DONNÉES D'EXPÉDITION

	DIMENSIONES DIMENSIONS DIMENSIONS		VOLUMEN VOLUME VOLUME	PESO NETO NET WEIGHT POIDS NET	PESO BRUTO GROSS WEIGHT POIDS BRUT
Basic	L W H	182 cm 82 cm 50 cm	0,75 m ³	30 Kg	30 Kg
Chasis sin hidro Bath with frame Chassis sans hydromassage	L W H	184 cm 84 cm 82 cm	1,27 m ³	60,1 Kg	77 Kg
S0	L W H	184 cm 84 cm 82 cm	1,27 m ³	71,6 Kg	88,5 Kg
SX1	L W H	184 cm 84 cm 82 cm	1,27 m ³	69,1 Kg	86 Kg
SX2	L W H	184 cm 84 cm 82 cm	1,27 m ³	93,6 Kg	110,5 Kg
SX3	L W H	184 cm 84 cm 82 cm	1,27 m ³	102,6 Kg	119,5 Kg
SX4	L W H	184 cm 84 cm 82 cm	1,27 m ³	105,6 Kg	122,5 Kg
SX5	L W H	184 cm 84 cm 82 cm	1,27 m ³	70,1 Kg	87 Kg

SOLEIL QUADRA

CARACTERÍSTICAS • FEATURES • CARACTERISTIQUES

CLUB

DESCRIPCIÓN • DESCRIPTION

Bañera rectangular free standing fabricada con lámina acrílica de 5 mm blanco brillo.

Free-standing rectangular bath made from gloss white 5 mm sanitary grade acrylic sheet.

Baignoire rectangulaire free standing fabriquée en plaque acrylique de 5 mm en blanc brillant.

COLORES • COLOURS • COULEURS

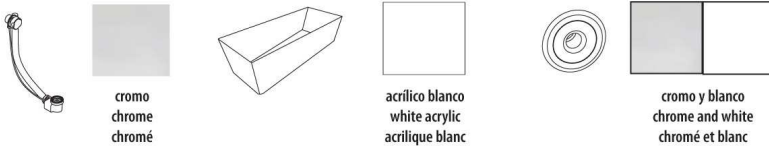

ACCESORIOS • ACCESSORIES • ACCESSOIRES

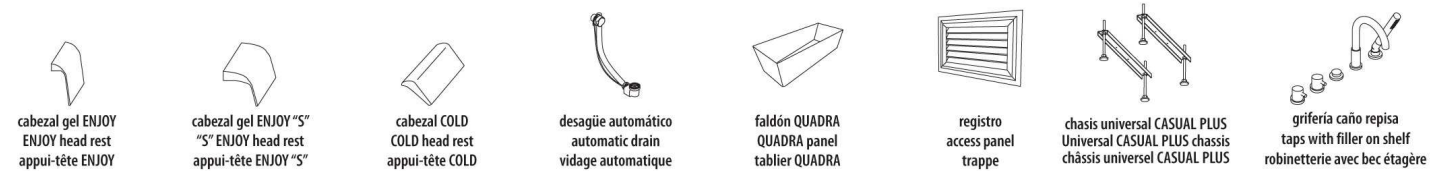











FORMATOS • FORMATS

Basic: 180x80 · 47h

Chasis • Chassis • Châssis 180x80x60h

EQUIPAMIENTO • EQUIPMENT • EQUIPEMENT

		 S0	 SX1	 SX2	 SX3	 SX4	 SX5
JETS		6	-	10	10	10	-
BLOWERS		-	9	-	9	9	9
CROMOTERAPIA CHROMOTHERAPY CHROMOTHERAPIE		-	-	-	-	10	10
DESINFECCIÓN DISINFECTION DÉSINFECTION		-	-	-	-	✓	-

* Ver características en la página 564-567.
* See features on page 564-567.
* Consultez caractéristiques en page 564-567.

RESUMEN DE ELECTRÓNICAS / ELECTRONICS OPTIONS / SOMMAIRE DE L'ÉLECTRONIQUES

BASIC

Bañera acrílica

BASIC

Acrylic bath

BASIC

Baignoire acrylique

CHASIS SIN HIDRO

Bañera acrílica con chasis metálico galvanizado

BATH WITH FRAME

Acrylic bath with metallic galvanised frame

CHASSIS SANS HYDROMASSAGE

Baignoire acrylique avec châssis métallique galvanisé



Teclado control pulsador retroiluminado
Hidromasaje agua
6 jets hidromasaje
Bomba 800W



Backlight keypad control
Water massage
6 hydromassage jets
Pump 800W



Clavier control retroéclairé
Hydromassage
6 jets hydromassage
Pompe 800W



Teclado control pulsador retroiluminado
Hidromasaje aire
9 jets aire extra-planos
Desagüe automático
Blower 400W



Backlight keypad control
Air massage
9 air jets extra-slim
Automatic drain
Blower 400W



Clavier control retroéclairé
Massage air
9 jets air extraplat
Vidage automatique
Blower 400W



Teclado control pulsador retroiluminado
Hidromasaje agua
10 jets hidromasaje extra-planos
Bomba 800W
Desagüe automático



Backlight keypad control
Water massage
10 hydromassage jets extra-slim
Pump 800W
Automatic drain



Clavier control retroéclairé
Hydromassage
10 jets hydromassage extraplat
Pompe 800W
Vidage automatique



Teclado control pulsador retroiluminado
Hidromasaje agua
10 jets hidromasaje extra-planos
Bomba 800W
Hidromasaje aire
9 jets aire extra-planos
Blower 400W
Desagüe automático



Backlight keypad control
Water massage
10 hydromassage jets extra-slim
Pump 800W
Air massage
9 air jets extra-slim
Blower 400W
Automatic drain



Clavier control retroéclairé
Hydromassage
10 jets hydromassage extraplat
Pompe 800W
Massage air
9 jets air extraplat
Blower 400W
Vidage automatique



Teclado control pulsador retroiluminado
Hidromasaje agua
10 jets hidromasaje
Bomba 800W
Hidromasaje aire
9 jets aire
Blower 400W
Desagüe automático
10 focos cromoterapia extra-planos
Desinfección
No disponible en versión encastre



Backlight keypad control
Water massage
10 hydromassage jets extra-slim
Pump 800W
Air massage
9 air jets extra-slim
Blower 400W
Automatic drain
10 chromotherapy lights extra-slim
Disinfection
Not available in built-in version



Clavier control retroéclairé
Hydromassage
10 jets hydromassage extraplat
Pompe 800W
Hydromassage air
9 jets air extraplat
Blower 400W
Vidage automatique
10 foyers chromotherapie extraplat
Désinfection
Version encastre non disponible



Teclado control pulsador retroiluminado
Hidromasaje aire
9 jets aire extra-planos
Blower 400W
Desagüe automático
10 focos cromoterapia extra-planos
No disponible en versión encastre



Backlight keypad control
Air massage
9 air jets extra-slim
Blower 400W
Automatic drain
10 chromotherapy lights extra-slim
Not available in built-in version



Clavier control retroéclairé
Hydromassage air
9 jets air extraplat
Blower 400W
Vidage automatique
10 foyers chromotherapie extraplat
Version encastre non disponible

SOLEIL QUADRA

180 x 80

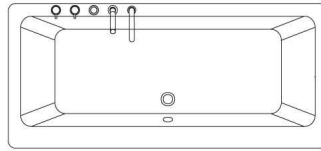

blanco brillo
white gloss
blanc brillant

Volumen agua 214 l.
Water volume 214 l.
Volume d'eau 214 l.

BASIC

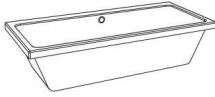

GRIFERÍA TAPS ROBINETTERIE	REF. KEA KEA CODE CODE KEA	REF. SAP SAP CODE CODE SAP	PUNTOS POINTS POINTS
* -	S107500002	100050674	
**	S107500004	100050676	



* Incluye desagüe automático • Automatic drain included • Vidage automatique inclus

** Grifería caño repisa, incluye desagüe automático

** Taps with filler on shelf, automatic drain filler included

** Robinetterie avec bec étagère, vidage automatique inclus

ACCESORIOS • ACCESSORIES • ACCESSOIRES



DESCRIPCIÓN DESCRIPTION DESCRIPTION	COLOR COLOUR COULEUR	REF. KEA KEA CODE CODE KEA	REF. SAP SAP CODE CODE SAP	PUNTOS POINTS POINTS
Desagüe automático NEXT • Automatic drain NEXT • Vidage automatique NEXT		S904410000	100060498	
Cabezal gel ENJOY • ENJOY head rest • Appui-tête ENJOY		S802305001	100056383	
		S802305002	100056384	
		S802305005	100056387	
Cabezal gel ENJOY "S" • "S" ENJOY head rest • Appui-tête ENJOY "S"		S802305010	100060780	
		S802305009	100060753	
		S802305008	100060767	
Cabezal COLD • COLD head rest • Appui-tête COLD		S809500016	100066186	
Kit chasis universal CASUAL PLUS • CASUAL PLUS universal chassis Kit • Kit châssis universel CASUAL PLUS		S802305007	100060499	

CHASIS SIN HIDRO • BATH WITH FRAME • CHASSIS SANS HYDROMASSAGE

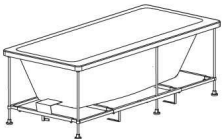

ACABADO FINISH FINITION	GRIFERÍA TAPS ROBINETTERIE	REF. KEA KEA CODE CODE KEA	REF. SAP SAP CODE CODE SAP	PUNTOS POINTS POINTS
encastre built-in encastrement	* -	S107500025	100084751	
	**	S107500026	100084752	
	*** -	S107500001	100050673	
	**	S107500003	100050675	



* Incluye desagüe automático • Automatic drain included • Vidage automatique inclus

** Grifería caño repisa, incluye desagüe automático

** Taps with filler on shelf, automatic drain filler included

** Robinetterie avec bec étagère, vidage automatique inclus

*** Incluye desagüe automático

*** Automatic drain included

*** Vidage automatique inclus

ACCESORIOS • ACCESSORIES • ACCESSOIRES



DESCRIPCIÓN DESCRIPTION DESCRIPTION	COLOR COLOUR COULEUR	REF. KEA KEA CODE CODE KEA	REF. SAP SAP CODE CODE SAP	PUNTOS POINTS POINTS
Desagüe automático NEXT • Automatic drain NEXT • Vidage automatique NEXT		S904410000	100060498	
Cabezal gel ENJOY • ENJOY head rest • Appui-tête ENJOY		S802305001	100056383	
		S802305002	100056384	
		S802305005	100056387	
Cabezal gel ENJOY "S" • "S" ENJOY head rest • Appui-tête ENJOY "S"		S802305010	100060780	
		S802305009	100060753	
		S802305008	100060767	
Cabezal COLD • COLD head rest • Appui-tête COLD		S809500016	100066186	
Registro rejilla bañera • Bath access panel • Trappe de visite baignoire		S904603473	250021559	

SOLEIL QUADRA

180 x 80

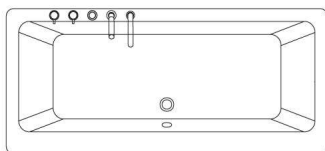

blanco brillo
white gloss
blanc brillant

Volumen agua 214 l.
Water volume 214 l.
Volume d'eau 214 l.

S0



POSICIÓN POSITION POSITION	GRIFERÍA TAPS ROBINETTERIE	REF. KEA KEA CODE CODE KEA	REF. SAP SAP CODE CODE SAP	PUNTOS POINTS POINTS
encastre built-in encastrement	* -	S107500024	100078688	
	**	S107500009	100078653	
	*** -	S107500023	100078689	
	**	S107500006	100078654	



* Incluye desagüe automático • Automatic drain included • Vidage automatique inclus

** Grifería caño repisa, incluye desagüe automático
** Taps with filler on shelf, automatic drain filler included
** Robinetterie avec bec étagère, vidage automatique inclus

*** Incluye desagüe automático
*** Automatic drain included
*** Vidage automatique inclus

ACCESORIOS • ACCESSORIES • ACCESSOIRES



DESCRIPCIÓN DESCRIPTION DESCRIPTION	COLOR COLOUR COULEUR	REF. KEA KEA CODE CODE KEA	REF. SAP SAP CODE CODE SAP	PUNTOS POINTS POINTS
Desagüe automático NEXT • Automatic drain NEXT • Vidage automatique NEXT		S904410000	100060498	
Cabezal gel ENJOY • ENJOY head rest • Appui-tête ENJOY		S802305001	100056383	
		S802305002	100056384	
		S802305005	100056387	
Cabezal gel ENJOY "S" • "S" ENJOY head rest • Appui-tête ENJOY "S"		S802305010	100060780	
		S802305009	100060753	
		S802305008	100060767	
Cabezal COLD • COLD hEad rest • Appui-tête COLD		S809500016	100066186	
Registro rejilla bañera • Bath access panel • Trappe de visite baignoire		S904603473	250021559	

SX1



POSICIÓN POSITION POSITION	GRIFERÍA TAPS ROBINETTERIE	REF. KEA KEA CODE CODE KEA	REF. SAP SAP CODE CODE SAP	PUNTOS POINTS POINTS
encastre built-in encastrement	-	S107500010	100078655	
	*	S107500017	100078656	
	-	S107500008	100078657	
	*	S107500011	100078658	



* Incluye desagüe automático con sistema de drenaje
* Includes automatic waste with drainage system
* Comprend écoulement automatique avec système de drainage

** Grifería caño repisa • Taps and filler on shelf • Robinetterie bec étagère

ACCESORIOS • ACCESSORIES • ACCESSOIRES



DESCRIPCIÓN DESCRIPTION DESCRIPTION	COLOR COLOUR COULEUR	REF. KEA KEA CODE CODE KEA	REF. SAP SAP CODE CODE SAP	PUNTOS POINTS POINTS
Cabezal gel ENJOY • ENJOY head rest • Appui-tête ENJOY		S802305001	100056383	
		S802305002	100056384	
		S802305005	100056387	
Cabezal gel ENJOY "S" • "S" ENJOY head rest • Appui-tête ENJOY "S"		S802305010	100060780	
		S802305009	100060753	
		S802305008	100060767	
Cabezal COLD • COLD head rest • Appui-tête COLD		S809500016	100066186	
Registro rejilla bañera • Bath access panel • Trappe de visite baignoire		S904603473	250021559	

SOLEIL QUADRA

180 x 80

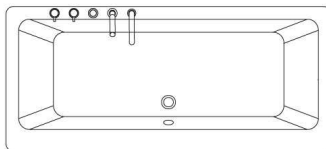

blanco brillo
white gloss
blanc brillant

Volumen agua 214 l.
Water volume 214 l.
Volume d'eau 214 l.

SX2



POSICIÓN POSITION POSITION	GRIFERÍA TAPS ROBINETTERIE	REF. KEA KEA CODE CODE KEA	REF. SAP SAP CODE CODE SAP	PUNTOS POINTS POINTS
encastre built-in encastrement	-	S107500018	100078659	
		S107500020	100078660	
	-	S107500021	100078661	
		S107500007	100078662	

* Incluye desagüe automático con sistema de drenaje
* Includes automatic waste with drainage system
* Comprend écoulement automatique avec système de drainage

* Grifería caño repisa - Taps and filler on shelf - Robinetterie bec étagère

SX3



POSICIÓN POSITION POSITION	GRIFERÍA TAPS ROBINETTERIE	REF. KEA KEA CODE CODE KEA	REF. SAP SAP CODE CODE SAP	PUNTOS POINTS POINTS
encastre built-in encastrement	-	S107500013	100078663	
		S107500014	100078664	
	-	S107500022	100078665	
		S107500012	100078666	

* Incluye desagüe automático con sistema de drenaje
* Includes automatic waste with drainage system
* Comprend écoulement automatique avec système de drainage

* Grifería caño repisa - Taps and filler on shelf - Robinetterie bec étagère

SX4



POSICIÓN POSITION POSITION	GRIFERÍA TAPS ROBINETTERIE	REF. KEA KEA CODE CODE KEA	REF. SAP SAP CODE CODE SAP	PUNTOS POINTS POINTS
	-	S107500019	100078667	
		S107500005	100078668	

* Incluye desagüe automático con sistema de drenaje
* Includes automatic waste with drainage system
* Comprend écoulement automatique avec système de drainage

* Grifería caño repisa - Taps and filler on shelf - Robinetterie bec étagère

SX5



POSICIÓN POSITION POSITION	GRIFERÍA TAPS ROBINETTERIE	REF. KEA KEA CODE CODE KEA	REF. SAP SAP CODE CODE SAP	PUNTOS POINTS POINTS
	-	S107500015	100078669	
		S107500016	100078670	

* Incluye desagüe automático con sistema de drenaje
* Includes automatic waste with drainage system
* Comprend écoulement automatique avec système de drainage

* Grifería caño repisa - Taps and filler on shelf - Robinetterie bec étagère

ACCESORIOS • ACCESSORIES • ACCESSOIRES



DESCRIPCIÓN DESCRIPTION DESCRIPTION	COLOR COLOUR COULEUR	REF. KEA KEA CODE CODE KEA	REF. SAP SAP CODE CODE SAP	PUNTOS POINTS POINTS
Cabezal gel ENJOY · ENJOY head rest · Appui-tête ENJOY		S802305001	100056383	
		S802305002	100056384	
		S802305005	100056387	
Cabezal gel ENJOY "S" · "S" ENJOY head rest · Appui-tête ENJOY "S"		S802305010	100060780	
		S802305009	100060753	
		S802305008	100060767	
Cabezal COLD · COLD head rest · Appui-tête COLD		S809500016	100066186	
Registro rejilla bañera · Bath access panel · Trappe de visite baignoire		S904603473	250021559	
Garrafa Aquanet · Aquanet bottle · Bouteille Aquanet		S904608477	250020738	